

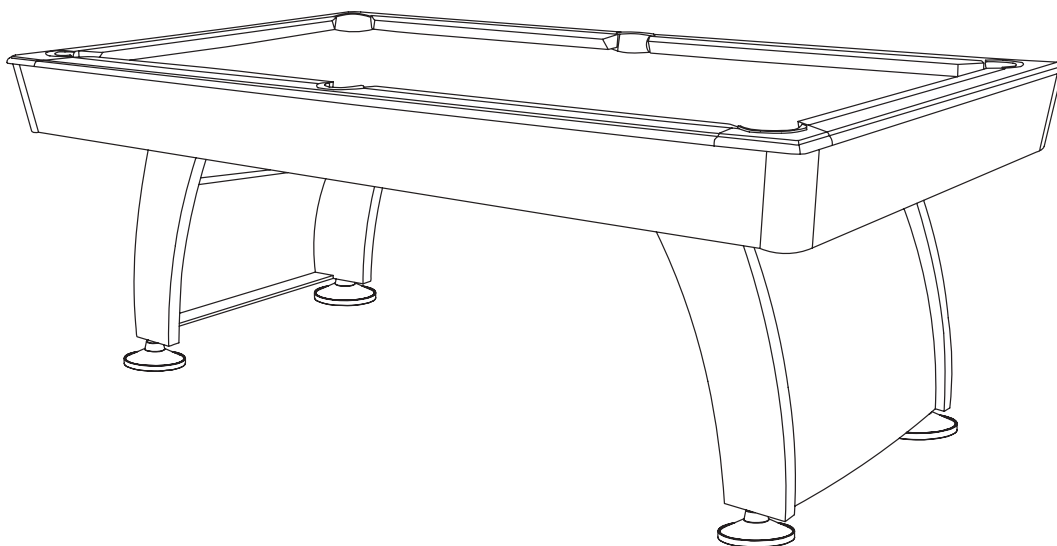

**Phoenix MMXI**  
**3 in 1 Billiard Table**  
Item 64-0145

# PHOENIX MMXI 7 FOOT 3 IN 1 BILLIARD TABLE



## Replacement Parts

Order direct at [www.gldproducts.com](http://www.gldproducts.com)  
or call our Customer Service department at  
**(800) 225-7593 ext. 113**  
8 am to 4:30 pm Central Standard Time

**GLD Products**

**Phoenix MMXI  
3 in 1 Billiard Table**

Item 64-0145

**Staple your receipt here.**

**Important:** A copy of your receipt will be needed to activate your warranty (see page page 14)



***GLD Products***

***Phoenix MMXI  
3 in 1 Billiard Table***  
Item 64-0145

***Congratulations and THANK YOU for purchasing the Phoenix MMXI 7 Foot 3 in 1 Billiard Table. You have chosen a product that should provide years of entertainment. To assist you with customer service and warranty claims, staple your receipt to the inside cover, then keep this manual in a safe place for future reference.***

**GLD Products**

S84 W19093 Enterprise Drive  
Muskego, WI 53150 USA  
1-800-225-7593 ext. 113  
Fax: 1-800-841-6944  
Email: [gld@gldmfg.com](mailto:gld@gldmfg.com)  
Web: [www.gldproducts.com](http://www.gldproducts.com)

This manual may have been updated. For the latest manual visit the GLD products website.



















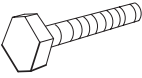

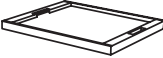

	<p>Place your package near the location where it will be used. Carefully unpack all components and verify you have all the correct pieces.</p> <p>If you notice missing or defective parts, please call us at: <b>1-800-225-7593 ext. 113</b></p>
---	---

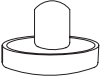

	<p>Please read and understand all instructions before beginning assembly.</p> <p><b>This assembly will require 2 adults.</b></p> <p>This product is not for use by children without adult supervision.</p>
---	--

**GLD Products**

**Phoenix MMXI 3 in 1 Billiard Table**

Item 64-0145

Part No./ Qty	Illustration/ Order Number	Part No./ Qty	Illustration/ Order Number	Part No./ Qty	Illustration/ Order Number
1 Qty. 2	 Left Leg Order No. 1-213	2 Qty. 2	 Right Leg Order No. 1-214	3 Qty. 4	 Leg Support Order No. 1-215
4 Qty. 1	 Table Top Assembly Order No. 1-225	5 Qty. 2	 Leg End Panel Order No. 1-217	6 Qty. 16	 1/4" x 2" Bolt Order No. 2-180
7 Qty. 16	 1/4" Washer 19 mm Order No. 1-220	8 Qty. 16	 1/4" Barrel Nut Order No. 2-12	9 Qty. 12	 5/16" x 2" Bolt Order No. 1-11
10 Qty. 12	 5/16" Washer 19 mm Order No. 1-90	11 Qty. 1	 Hockey Table with Table Tennis Order No. 1-218	12 Qty. 4	 Leg Leveler Order No. 1-219
13 Qty. 1	 Billiard Balls Order No. 2-21	14 Qty. 1	 Triangle Order No. 2-27	15 Qty. 2	 Cue Order No. 2-23
16 Qty. 2	 Chalk Order No. 2-24	17 Qty. 1	 Brush Order No. 1-221	18 Qty. 2	 Goalie Order No. 2-18
19 Qty. 2	 Hockey Felt Order No. 2-19	20 Qty. 2	 Hockey Puck Order No. 2-20	21 Qty. 2	 Table Tennis Post Order No. 1-222
22 Qty. 2	 Table Tennis Racket Order No. 8-5	23 Qty. 2	 Table Tennis Ball Order No. 8-4	24 Qty. 1	 Table Tennis Net Order No. 1-223

<p><b>25</b></p>  <p>Qty. 1</p> <p>Wrench Order No. 1-17</p>	<p><b>26</b></p>  <p>Qty. 1</p> <p>Allen Wrench Order No. 2-116</p>	
---	--	--

**IF YOU HAVE A WARRANTY CLAIM, CALL US FIRST**

Please see page 14.

**GLD Products**

Available 8 am to 4:30 pm Central Standard Time

S84 W19093 Enterprise Drive  
Muskego, WI 53150 USA  
1-800-225-7593 ext. 113  
Fax: 1-800-841-6944  
Email: [gld@gldmfg.com](mailto:gld@gldmfg.com)  
Web: [www.gldproducts.com](http://www.gldproducts.com)

For all claims, please have your receipt and item number when you call. The product item number can be found on the front cover.

**If you are instructed to return the product for service, you are responsible for shipping the unit at your expense.**

**PRODUCT REGISTRATION**

**Important: The product registration form on page 15 and a copy of your receipt must be completed and returned within 10 days of purchase to validate your warranty.**

**Preparing for Assembly**

- Be sure to unpack all of the parts included in this package. Some parts may be in obscure locations of the packaging. Check inside any tubes or sleeves. Save all packing material until the product is fully assembled and functional.
- Compare the parts in your package with the Parts Identifier description on page 5.

**Tools Required**

- Wrench (#25)
- Allen Wrench (#26)
- Level (not included)
- Electric screwdriver may be helpful. **CAUTION:** You must set at **LOW TORQUE** and use extreme caution because you could overtighten the hardware, strip the screws, or damage the table.



**Assembly Tips**

Make sure you understand the following before you begin to assemble your pool table.

1. READ THIS MANUAL all the way through before beginning assembly.
2. When installing parts that have more than one bolt, start ALL bolts in that part by hand before tightening anything.
3. Some drawings or images in this manual may not look exactly like your product.
4. You will need a second adult to assist with this assembly.

**Note:** Save all packing materials until the parts have been inspected and the table is assembled.

**Unpack the Pieces**

- Lay the box top side down on a flat surface (floor). You may want this near your area of assembly.
- Unpack the boxes and part bags. Inspect and count the parts. The Parts Identifier page can be used to record your results.
- If any parts are damaged or missing contact GLD customer service.
- Missing fasteners may be purchased at a hardware store using the descriptions on the Parts Identifier page(s).

**STEP 1 - ASSEMBLE THE LEGS**

1. Lay the leg supports (#3) on the floor with the side that has the four holes facing up. Put a barrel nut (#8) in each hole with the threaded hole facing the short edge.
2. Hold one of the legs (#1 or #2) on edge. Hold the leg support (#3) against the leg, lining up the bolt holes. The holes for the barrel nuts (#8) should face toward the bottom of the leg.
3. Place a washer (#7) over a bolt (#6) and insert the bolt through the leg into the barrel nut in the leg supports. Finger start the bolt. Repeat for the second bolt and finger tighten both bolts.
4. Hold the second leg in position. Insert the two bolts (#6) with washers (#7) through the leg and finger tighten.
5. Repeat Steps 3 & 4 for the bottom leg support (#3).

6. The leg end panel (#5) should slide into the channels on the legs. It may be helpful to stand the leg assembly up as shown. This will help prevent the leg assembly from becoming angled and preventing the leg end panel from sliding into place. The side of the leg end panel that is visually better should be to the outside of the curve.
7. When the leg end panel (#5) is in place tighten all eight support bolts (#6) using the allen wrench (#26).
8. Repeat for the second leg assembly

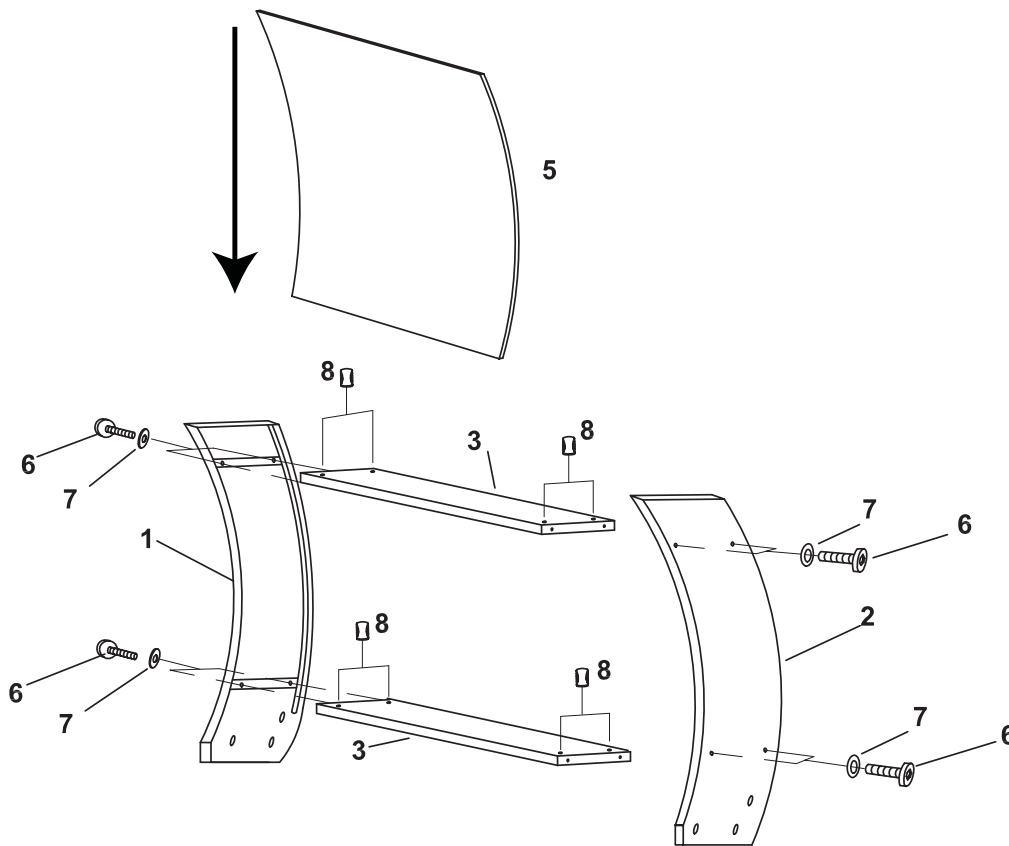

**STEP 2 - CONNECT LEG ASSEMBLIES**

1. Place the table top upside down on a flat surface.
2. Position one leg assembly from Step 1 inside the framework of the table top.
3. Place a washer (#10) over a bolt (#9). Insert the bolt through the frame and into the threaded hole in the leg assembly. Finger tighten.
4. Repeat for the other five bolts.
5. Tighten all six bolts using the wrench (#25)
6. Repeat for the second leg assembly.
7. Screw a leg leveler (#12) halfway into the hole in each leg.

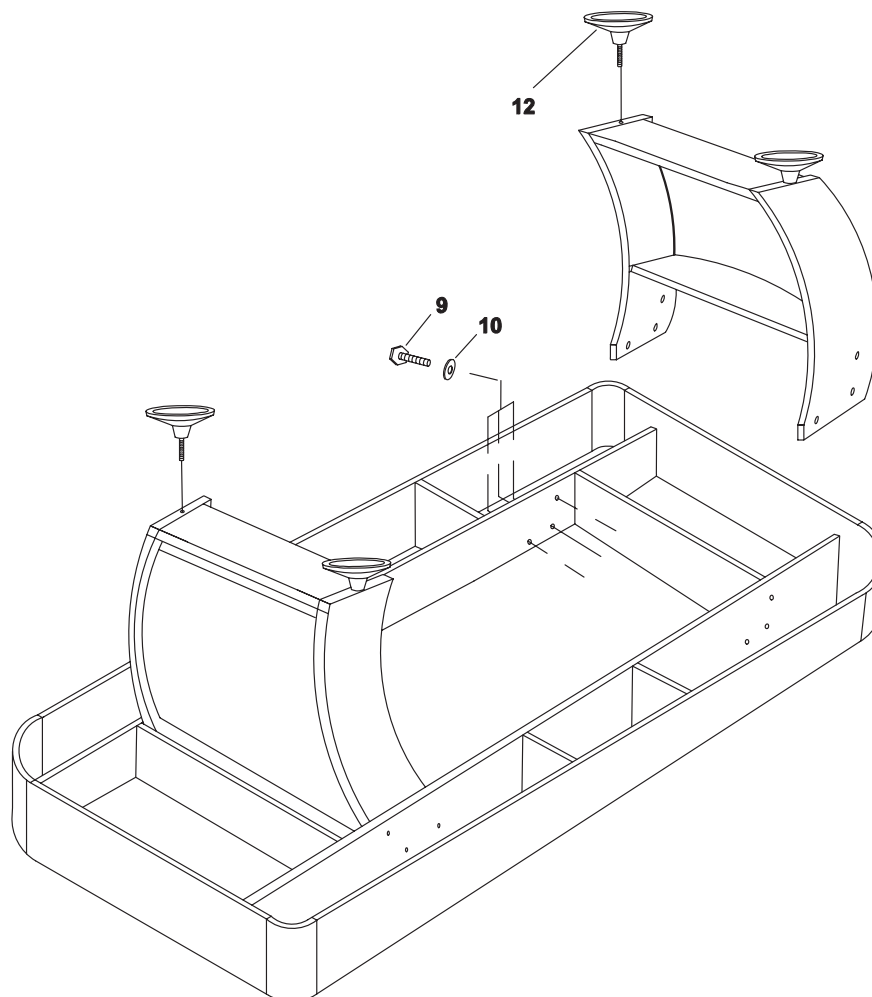
**STEP 3 - TURN BASE OVER**

The base assembly is ready to be turned over.

USE AT LEAST TWO PEOPLE TO LIFT THE BASE ASSEMBLY AND TURN IT OVER TO REST ON THE LEGS.

**DO NOT ROLL THE TABLE OVER.** This will place a sideways force on the legs. The legs should be off the floor until the base assembly is rotated completely. Set the base assembly down.

If visually the leg positions need adjusting, loosen the bolts, adjust, and retighten.

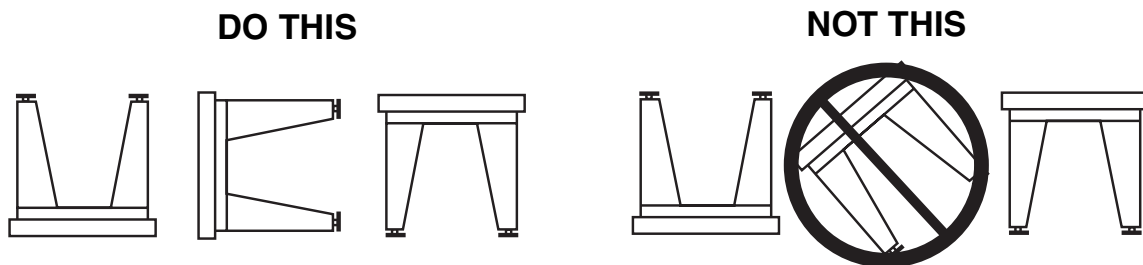

**STEP 4 - LEVEL THE TABLE BASE**

1. Place table into position in your room (13' 4" x 17' 0" minimum). Measure ends at base frame to walls, making sure there is at least 60" between the table and the wall. You do not want to move the table after this step.
2. Use a carpenters level to find the low side.
3. Lift the table leg off the floor and unscrew the leveler in the base a small amount.
4. Repeat until the base is level. Be sure to check level at both ends side to side as well as the longer length. Readjustment may be needed in the future.
5. Your table is ready for use.

**STEP 5 - USING THE ADDITIONAL TABLE TOP**

A second table top insert is used to provide a playing surface for Table Tennis and Hockey. When using the insert, the Pool Table surface must be clean. Any debris may create an imperfection in the pool playing surface.

Place the insert on the pool playing surface and inside the bumpers. When using the Table Tennis surface, press the table tennis posts (#21) in place. Tie the table tennis net (#24) in place. The net should be stretched enough to be tight but not bend the two posts.

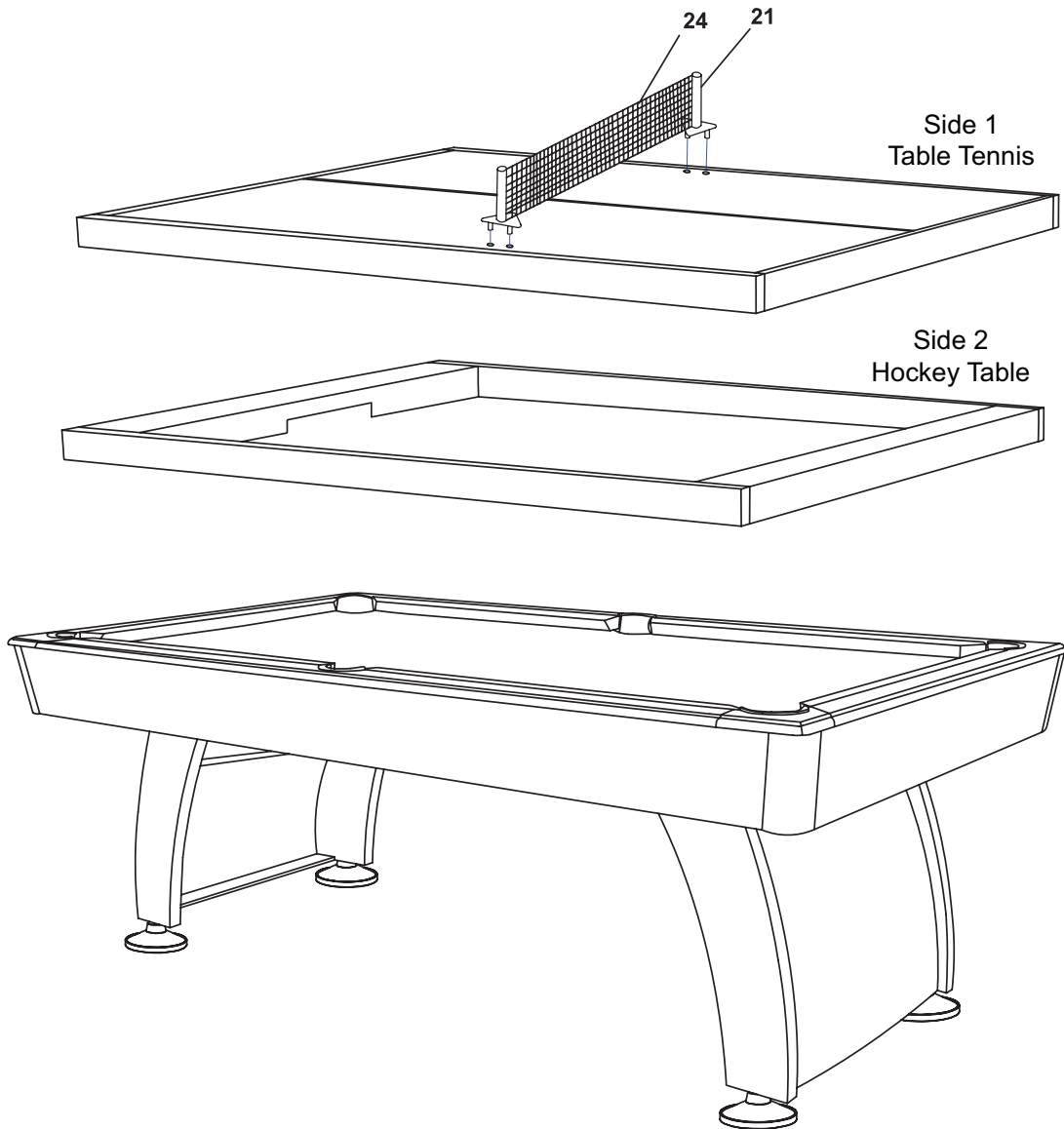

**Care and Use of your Table**

- This product is intended for INDOOR use only.
- DO NOT sit, climb, or lean on the table.
- DO NOT drag the table when moving it. This will damage the legs.
- Keep your table covered. The playing surface can be brushed to keep clean.
- DO NOT lift the table by placing your hands under the pockets, and do not sit, lean or put pressure on the pockets.
- The cloth playing surface can rip or tear. Keep sharp objects off the playing surface.
- Some “trick shots” may tear or dimple the cloth surface.
- To clean the hard surfaces spray a cloth with a mild cleaner and wipe.

**90-DAY LIMITED WARRANTY**

The Manufacturer warrants to the original retail purchaser that this product is free from defects in material and workmanship under normal use and conditions for a period of ninety (90) days from the date of original purchase. The Manufacturer's liability is limited to the repair or replacement, at its option, of any defective product and shall not include any liability for indirect, incidental or consequential damages of any kind.

Should this product become defective due to material or workmanship within the warranty period, contact our Customer Service Department. This warranty is not transferable and does not cover normal wear and tear or damage caused by improper usage, negligence, misuse, abuse, transportation damage, acts of nature, or accident (including failure to follow the instructions in this manual). It does not cover expendable items such as batteries, light bulbs, fuses, accessories, cosmetic parts and other items that wear out due to normal usage, including felt covered areas of the playing surface. This warranty is also void if the product is disassembled and reassembled, damaged, modified from its original state, or used for other than indoor personal residential use (no commercial or rental applications).

This warranty gives you specific legal rights, and you may have other rights which vary from state to state.

**IF YOU HAVE A WARRANTY CLAIM, CALL US FIRST (8 - 4:30 CST)**

Please have your receipt and item number (found on the front cover) when you call.

**GLD Products**

S84 W19093 Enterprise Drive  
Muskego, WI 53150 USA  
1-800-225-7593 ext. 113  
Fax: 1-800-841-6944  
Email: [gld@gldmfg.com](mailto:gld@gldmfg.com)  
Web: [www.gldproducts.com](http://www.gldproducts.com)

**If you are instructed to return the product for service, you are responsible for shipping the unit at your expense to the above address in packaging that will protect against further damage. All warranty or repair requests require a Return Authorization Number prior to returning the item.**

**PRODUCT REGISTRATION**

**Important:** The product registration form on page 15 must be completed and returned along with a copy of your receipt within 10 days of purchase to validate your warranty.

# REGISTER YOUR PRODUCT

Place postage here

Complete this form, include a copy of your receipt, fold, tape (do not staple) and return within 10 days of purchase. This protects your warranty and will help us develop new products!

Cut here.

**GLD Products**  
 Warranty Department  
 S84 W19093 Enterprise Drive  
 Muskego, WI 53150 USA

Fold here second.



- |                       |                            |
|-----------------------|----------------------------|
| GAME TABLES           | HOME CASINO                |
| GAMES AND ACCESSORIES | BILLIARD CUES              |
| BILLIARD ACCESSORIES  | DARTBOARDS                 |
| SOFT-TIP DARTS        | STEEL-TIP DARTS            |
| FLIGHTS AND SHAFTS    | DART CASES AND ACCESSORIES |

Fold here first.

Name	Date of Purchase
Address	Phone-Day
City	Phone-Evening
State                      Zip	Email
Purchase Price:	Item: <b>64-0145 Phoenix MMXI 3 in 1 Billiard Table</b>
Store Name:	

1. What are the top two reasons that influenced the purchase of this product? Select two.

- |  |  |
|--|--|
| <input type="checkbox"/> Brand reputation        | <input type="checkbox"/> Prior experience with another GLD product |
| <input type="checkbox"/> Saw in an advertisement | <input type="checkbox"/> Color/appearance                          |
| <input type="checkbox"/> Quality/durability      | <input type="checkbox"/> Other                                     |
| <input type="checkbox"/> Value for price         |  |



2. How did you become aware of this product? Select two.

Saw in an advertisement  
Saw or used a friend's or relative's  
Received as a gift

Saw it in the store  
Recommended by another person  
Other

3. Rate your satisfaction with each of the following?

Assembly instructions  
Ease of assembly  
Packaging  
Overall product satisfaction

Excellent	Good	Fair	Poor

4. Were there any parts missing?

Yes

No

If so, which ones?

Order No. \_\_\_\_\_

5. Based on your experience, would you buy another GLD product?

Yes

No

6. Is this the first GLD product that you've owned? If No, what other product have you owned?:

Yes

No

\_\_\_\_\_

7. Have you owned products from:

Sportcraft

Harvard

Classic Sport

Other

8. When did you decide to purchase this product?

Before entering the store.

While in the store/impulse purchase

9. How many times per month will you use it?

1 to 3

4 to 8

9 to 15

16 +

10. Are you the intended user of this product?

Yes

No, indicate who: \_\_\_\_\_

11. Where will you use this product?

Home

Other: \_\_\_\_\_

12. Please tell us your gender?

Male

Female

13. And your marital status?

Married

Single

14. Age?

Under 25

25 - 40

40 - 60

Over 60

15. Which best describes your family income?

Under \$25,000

\$25,000 - \$49,999

\$50,000 - \$99,999

\$100,000 - 149,999

\$150,000 - \$199,999

Over \$200,000

16. Education:

Some high school

College degree

Completed high school

Graduate degree

**Remember to attach a copy of your receipt.**

**Mail To: GLD Products**  
 S84 W19093 Enterprise Drive  
 Muskego, WI 53150 USA  
 1-800-225-7593 • FAX 800-841-6944  
 Email: gld@gldmfg.com  
 Web Site: www.gldproducts.com

## Phoenix MMXI 3 in 1 Billiard Table

Item 64-0145

### Parts Re-Order Form

Name		Date
Address		Phone-Day
City		Phone-Evening
State	Zip	Email

Order No.	Description	Unit Price	Qty.	Total Amount
1-213	Left Leg	15.00		
1-214	Right Leg	15.00		
1-215	Leg Support	10.00		
1-217	Leg End Panel	15.00		
2-180	1/4" x 2" Bolt	0.75		
1-220	1/4" Washer 19 mm	0.20		
2-12	1/4" Barrel Nut	0.25		
1-11	5/16" x 2" Bolt	1.00		
1-90	5/16" Washer 19 mm	0.20		
1-218	Hockey Table With Table Tennis	110.00		
1-219	Leg Leveler	10.00		
2-21	Billiard Balls	30.00		
2-27	Triangle	6.00		
2-23	Cue	12.00		
2-24	Chalk	2.00		
1-221	Brush	5.00		
2-18	Goalie	6.00		
2-19	Hockey Felt	1.00		
2-20	Hockey Puck	1.50		
1-222	Table Tennis Post	4.00		
8-5	Table Tennis Racket	6.00		
8-4	Table Tennis Ball	1.00		
1-223	Table Tennis Net	6.00		
1-17	Wrench	1.00		
2-116	Allen Wrench	1.00		
1-225	Table Top Assembly	150.00		
		Subtotal		
Shipping will be added. If paid by Check or Money Order, call for quote.		S/H		
5.1% Waukesha Wisconsin tax will apply (subject to change).		Tax		
		Total		

**Method of Payment**

\_\_\_\_\_ Check or Money Order

\_\_\_\_\_ Credit Card

\_\_\_\_\_ Visa \_\_\_\_\_ MasterCard \_\_\_\_\_ Discover \_\_\_\_\_ American Express

Card # \_\_\_\_\_

Security Code # \_\_\_\_\_ Billing Address Zipcode \_\_\_\_\_

Signature \_\_\_\_\_ Exp. Date \_\_\_\_\_

**Shipping Address**

Name \_\_\_\_\_

Address \_\_\_\_\_ Phone \_\_\_\_\_

City \_\_\_\_\_ State \_\_\_\_\_ Zip \_\_\_\_\_



[www.gldproducts.com](http://www.gldproducts.com)

**GAME TABLES**

**HOME CASINO**

**GAMES AND ACCESSORIES**

**BILLIARD CUES**

**BILLIARD ACCESSORIES**

**DARTBOARDS**

**SOFT-TIP DARTS**

**STEEL-TIP DARTS**

**FLIGHTS AND SHAFTS**

**DART CASES AND ACCESSORIES**



**PROUD MANUFACTURER OF**



S84 W19093 Enterprise Drive • Muskego, WI 53150 USA  
262.679.8730 or 1.800.225.7593 tele  
262.679.8738 or 1.800.841.6944 fax  
262.679.8739 international fax  
Email: [gld@gldmfg.com](mailto:gld@gldmfg.com)  
[www.gldproducts.com](http://www.gldproducts.com)